



SIMONSWERK TECTUS®

New Versions

The completely concealed
hinge system

INDEX

TE 240 3D	up to 40 kg	6
TE 340 3D	up to 80 kg	7
TE 540 3D	up to 120 kg	8
TE 640 3D	up to 200 kg	9
TE 540 3D A8	up to 100 kg	10
TE 640 3D A8	up to 160 kg	11
TE 525 3D	up to 100 kg	12
Fixing FZ/1	Casing frame	13
Fixing SZ	Steel frame	14
<hr/>		
Assembly		15
<hr/>		
Adjustment		16
<hr/>		
Calculation formulas		17



»TECTUS« – the completely concealed hinge system

To enhance the range of TECTUS concealed hinges SIMONSWERK offers further options to complement this proven brand name.

The new TECTUS options for quality residential doors and heavy duty doors are distinguished by optimized and uniform construction of the hinge body. The newly developed convenient continuous height adjustment of +/- 3 mm prevents the door from sagging and enables the door manufacturer to align the door efficiently and hassle free. All types show a full hinge body which covers the routing entirely. The overall harmonious visual appearance of TECTUS with the small gap between door and jamb to avoid finger injury and maintenance-free slide bearings gives the TECTUS range an overall advantage over other hinge products.

New styles and applications can be achieved by using the A8 versions for door and frame claddings up to 8 mm allowing designers to specify glass or laminate door elements within an overall interior concept.

New versions with optimized load capacities

TE 240 3D	40 kg
TE 340 3D	80 kg
TE 540 3D	120 kg
TE 640 3D	200 kg

Versions for various door claddings

TE 540 3D A8	100 kg
TE 640 3D A8	160 kg

Version made of solid stainless steel

TE 525 3D	100 kg
-----------	--------

TECTUS® – NEW VERSIONS

Ambitious design, high load capacity, secure assembly and multi-faceted scope of application for high quality residential and heavy-duty doors.





TECTUS® – New versions

- increased and optimised load capacity
- versions for doors with claddings of up to 8 mm
- comfortable height adjustment
- distinctive TECTUS optical characteristic through 3-part hinge assembly and closed hinge body
- standardised door and frame routing for TE 340 3D and TE 640 3D A8
- high quality surface finishes: stainless steel, F1-powder-coated, F2-powder-coated, polished nickelled, polished brassed
- innovative surface designs - water transfer printing – please contact us for details.

SIMONSWERK
TECTUS®

TE 240 3D

for unrebated and rebated flush residential doors

Hinge **up to 40 kg**

Technical Data

Load capacity	40.0 kg
Length (door/frame)	155.0/155.0 mm
Width (door/frame)	18.0/21.0 mm
Cutter diameter	16.0 mm

Descriptive Text

SIMONSWERK TECTUS TE 240 3D Hinge. Completely concealed for unrebated and rebated flush doors with timber, steel and aluminium frames. Load capacity 40 kg, opening angle up to 180°, overall length 155 mm, right hand and left hand applicable, maintenance-free slide bearings, three-dimensionally adjustable: side +/- 3 mm, height +/- 3 mm, compression +/- 1.5 mm. Finish ...

Combination

Receiver	Block frame	Direct screwing
	Casing frame	TE 240 3D FZ/1
	Blind frame	Direct screwing
	Steel frame	TE 240 3D SZ
	Aluminium frame	according to specifications of the frame manufacturer

See page 13-14

Installation Tools

Jig	Universal milling frame
Template for universal milling frame	Frame side: No. 5 250691 6 Door side: No. 5 250692 6

Detailed information at www.bandsysteme.com

Finish

Stainless steel look, F1-coloured, F2-coloured, polished nickelled, polished brassed, powder-coated

Note

Finger protection due to a small gap between door and frame.

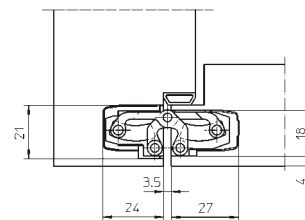
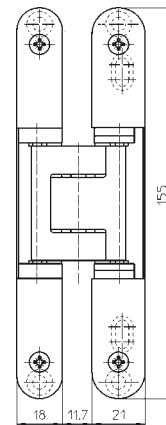

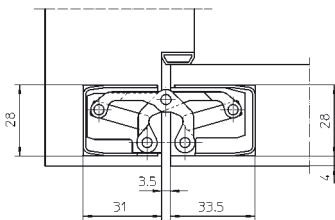
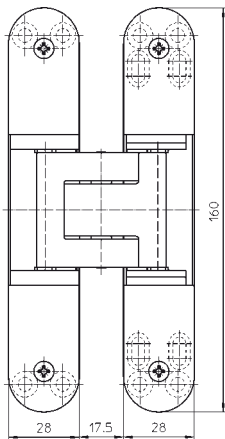

TE 340 3D

for unrebated residential doors

Hinge **up to 80 kg**

Technical Data

Load capacity	80.0 kg
Length (door/frame)	160.0/160.0 mm
Width (door/frame)	28.0/28.0 mm
Cutter diameter	24.0 mm

Descriptive Text

SIMONSWERK TECTUS TE 340 3D Hinge. Completely concealed for unrebated doors with timber, steel and aluminium frames. UL-certified, with comfortable 3D adjustment, load capacity 80 kg, opening angle up to 180°, overall length 160 mm, right hand and left hand applicable, maintenance-free slide bearings, three-dimensionally adjustable: side +/- 3 mm, height +/- 3 mm, compression +/- 1 mm. Finish ...

Combination

Receiver	Block frame	Direct screwing
	Casing frame	TE 340 3D FZ/1
	Blind frame	Direct screwing
	Steel frame	TE 340 3D SZ
	Aluminium frame	according to specifications of the frame manufacturer

See page 13-14

Installation Tools

Jig	Universal milling frame
Template for universal milling frame	Step 1: No. 5 250693 5
	Step 2: No. 5 250694 5

Detailed information at www.bandsysteme.com

Finish

Stainless steel look, F1-coloured, F2-coloured, polished nickelled, polished brassed, powder-coated

Note

Finger protection due to a small gap between door and frame.

Quality Marks



SIMONSWERK
TECTUS®

TE 540 3D

for unrebated heavy-duty doors with casing frames

Hinge up to 120 kg

Technical Data

Load capacity	120.0 kg
Length (door/frame)	200.0/200.0 mm
Width (door/frame)	32.0/32.0 mm
Cutter diameter	24.0 mm

Descriptive Text

SIMONSWERK TECTUS TE 540 3D Hinge. Completely concealed for unrebated doors with timber, steel and aluminium frames. UL-certified, with comfortable 3D adjustment, load capacity 120 kg, opening angle up to 180°, overall length 200 mm, right hand and left hand applicable, maintenance-free slide bearings, three-dimensionally adjustable: side +/- 3 mm, height +/- 3 mm, compression +/- 1 mm. Finish ...

Combination

Receiver	Block frame	Direct screwing
	Casing frame	TE 540 3D FZ/1
	Blind frame	Direct screwing
	Steel frame	TE 540 3D SZ
	Aluminium frame	according to specifications of the frame manufacturer

See page 13-14

Installation Tools

Jig	Universal milling frame
Template for universal milling frame	Step 1: No. 5 250680 5
	Step 2: No. 5 250681 5

Detailed information at www.bandsysteme.com

Finish

Stainless steel look, F1-coloured, F2-coloured, polished nickelled, polished brassed, powder-coated

Note

Finger protection due to a small gap between door and frame.

Function Range

Fire resistance, Smoke resistance, Soundproof, Burglar resistance

Quality Marks

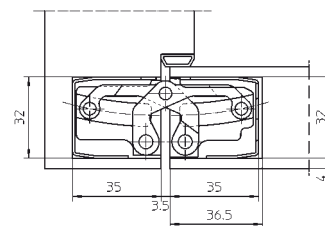
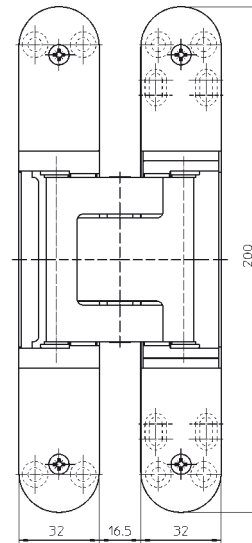



TE 640 3D

for unrebated high performance heavy-duty doors

Hinge		up to 200 kg
--------------	--	---------------------

Technical Data

Load capacity	200.0 kg
Length (door/frame)	240.0/240.0 mm
Width (door/frame)	32.0/32.0 mm
Cutter diameter	24.0 mm

Descriptive Text

SIMONSWERK TECTUS TE 640 3D Hinge. Completely concealed for unrebated, heavy-duty doors with timber, steel and aluminium frames. UL-certified, with comfortable 3D adjustment, load capacity 200 kg, opening angle up to 180°, overall length 240 mm, right hand and left hand applicable, maintenance-free slide bearings, three-dimensionally adjustable: side +/- 3 mm, height +/- 3 mm, compression +/- 1 mm. Finish ...

Combination

Receiver	Block frame	Direct screwing
	Casing frame	TE 640 3D FZ/1
	Blind frame	Direct screwing
	Steel frame	TE 640 3D SZ
	Aluminium frame	according to specifications of the frame manufacturer

See page 13-14

Installation Tools

Jig	Universal milling frame
Template for universal milling frame	Step 1: No. 5 250659 5
	Step 2: No. 5 250689 5

Detailed information at www.bandsysteme.com

Finish

Stainless steel look, F1-coloured, F2-coloured, polished nickelled, polished brassed, powder-coated

Note

Finger protection due to a small gap between door and frame.

Function Range

Fire resistance, Smoke resistance, Soundproof, Burglar resistance

Quality Marks

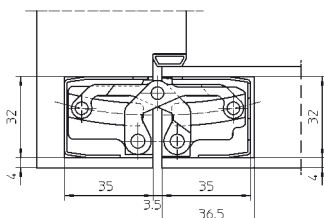
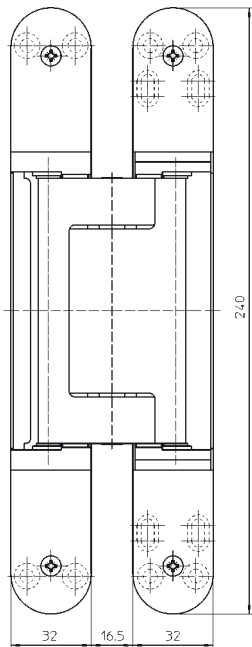

SIMONSWERK
TECTUS®

TE 540 3D A8

for unrebated heavy-duty doors with claddings up to 8 mm

Hinge up to 100 kg

Technical Data

Load capacity	100.0 kg
Length (door/frame)	200.0/200.0 mm
Width (door/frame)	per 32.0/37.0 mm
Cutter diameter	24.0 mm

Descriptive Text

SIMONSWERK TECTUS TE 540 3D A8 hinge for doors with claddings of up to 8 mm. Completely concealed for unrebated, heavy-duty doors with timber, steel and aluminium frames. UL-certified, load capacity 100 kg, opening angle up to 180°, overall length 200 mm, right hand and left hand applicable, maintenance-free slide bearings, three-dimensionally adjustable: side +/- 3 mm, height +/- 3 mm, compression +/- 1 mm. Finish ...

Combination

Receiver	Block frame	Direct screwing
	Casing frame	TE 540 3D FZ/1
	Blind frame	Direct screwing
	Steel frame	TE 540 3D A8 SZ
	Aluminium frame	according to specifications of the frame manufacturer
Accessories	Cover plate set	TE 540/640 3D A8 with radius

See page 13-14

Installation Tools

Jig	Universal milling frame
Template for universal milling frame	Step 1: No. 5 250680 5
	Step 2: No. 5 250681 5
	Step 3: No. 5 250682 5

Detailed information at www.bandsysteme.com

Finish

Stainless steel look, F1-coloured, F2-coloured, polished nickelled, polished brassed, powder-coated

Function Range

Fire resistance, Smoke resistance, Soundproof, Burglar resistance

Quality Marks

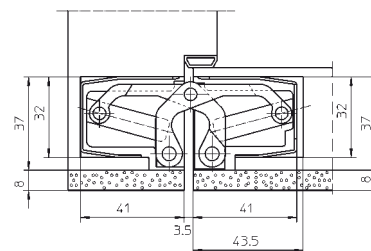
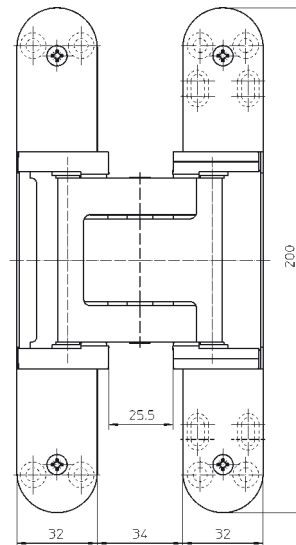



TE 640 3D A8

for unrebated high performance heavy-duty doors with claddings up to 8 mm

Hinge		up to 160 kg
--------------	--	---------------------

Technical Data

Load capacity	160.0 kg
Length (door/frame)	240.0/240.0 mm
Width (door/frame)	per 32.0/37.0 mm
Cutter diameter	24.0 mm

Descriptive Text

SIMONSWERK TECTUS TE 640 3D A8 hinge for doors with claddings of up to 8 mm. Completely concealed for unrebated, heavy-duty doors with timber, steel and aluminium frames. UL-certified, load capacity 160 kg, opening angle up to 180°, overall length 240 mm, right hand and left hand applicable, maintenance-free slide bearings, three-dimensionally adjustable: side +/- 3 mm, height +/- 3 mm, compression +/- 1 mm. Finish ...

Combination

Receiver	Block frame	Direct screwing
	Casing frame	TE 640 3D FZ/1
	Blind frame	Direct screwing
	Steel frame	TE 640 3D A8 SZ
	Aluminium frame	according to specifications of the frame manufacturer

Accessories	Cover plate set	TE 540/640 3D A8 with radius
-------------	-----------------	------------------------------

See page 13-14

Installation Tools

Jig	Universal milling frame
Template for universal milling frame	Step 1: No. 5 250659 5
	Step 2: No. 5 250689 5
	Step 3: No. 5 250690 5

Detailed information at www.bandsysteme.com

Finish

Stainless steel look, F1-coloured, F2-coloured, polished nickelled, polished brassed, powder-coated

Function Range

Fire resistance, Smoke resistance, Soundproof, Burglar resistance

Quality Marks

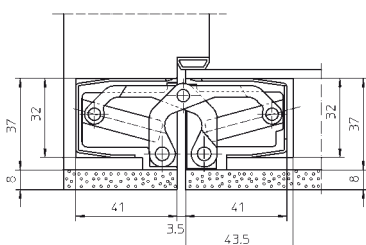
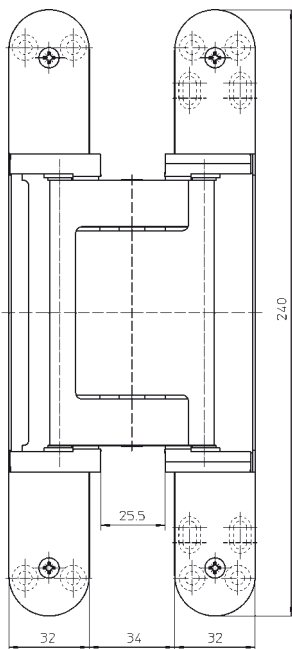

SIMONSWERK
TECTUS®

TE 525 3D

made of solid stainless steel for unrebated heavy-duty doors

Hinge up to 100 kg

Technical Data

Load capacity	100.0 kg
Length (door/frame)	155.0/155.0 mm
Width (door/frame)	26.0/26.0 mm
Cutter diameter	24.0 mm

Descriptive Text

SIMONSWERK TECTUS hinge TE 525 3D made from solid stainless steel. Completely concealed for unrebated doors with timber, steel or aluminium frames. UL-certified, load capacity 100 kg, opening angle up to 180°, total length 155 mm, right hand and left hand applicable, maintenance-free slide bearing technology, three-dimensionally adjustable: Side +/- 3.0 mm and height +/- 3.0 mm, compression +/- 1.0 mm. Finish...

Combination

Receiver	Block frame	Direct screwing
	Casing frame	TE 525 3D FZ/1
	Blind frame	Direct screwing
	Steel frame	TE 525 3D SZ
	Aluminium frame	according to specifications of the frame manufacturer
Accessories	Cable set	TE 525 3D MK

See page 13-14

Installation Tools

Jig	Universal milling frame Drilling jig TE 525 3D
Template for universal milling frame	frame/leaf: No. 5 250547 6

Detailed information at www.bandsysteme.com

Finishes

Satin brushed stainless steel

Note

Finger protection due to a small gap between door and frame.

Function Range

Fire resistance, Smoke resistance, Soundproof, Burglar resistance

Quality Marks

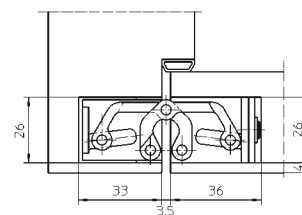
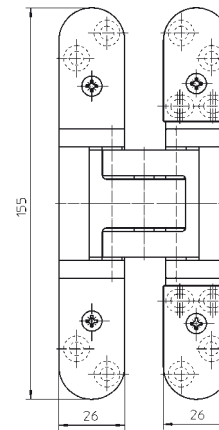

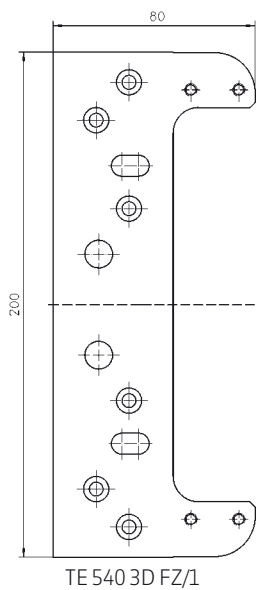
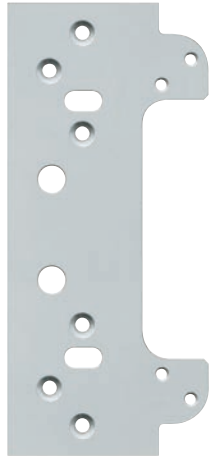

TE 540 3D FZ/1

Fixing plate TECTUS series

for unrebated quality and high performance doors with casing frames

Fixing

Casing frame

Descriptive text

SIMONSWERK fixing plate TECTUS TE ... 3D FZ/1 for casing frames with hinge TECTUS TE ... 3D for unrebated doors. Finish...

Combination

Hinge	TE 240 3D TE 340 3D TE 525 3D TE 540 3D TE 640 3D TE 540 3D A8 TE 640 3D A8
-------	---

Finishes

galvanised

Note

Spacers for casing strengths 22-28 mm are included.
Please specify the exact hinge in your order.

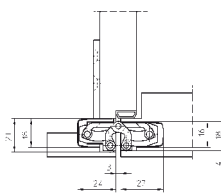

TE 240 3D with
TE 240 3D FZ/1

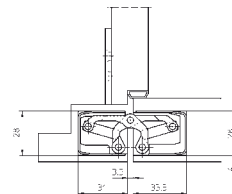

TE 340 3D with
TE 340 3D FZ/1

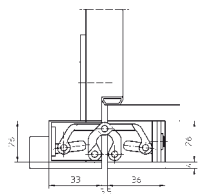

TE 525 3D with
TE 525 3D FZ/1

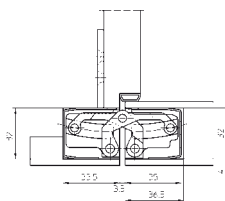

TE 540 3D with
TE 540 3D FZ/1

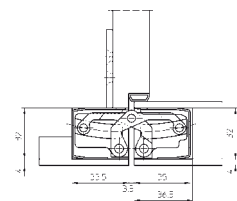

TE 640 3D with
TE 640 3D FZ/1

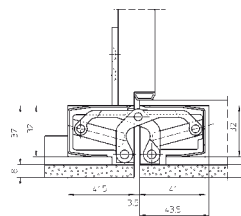

TE 540 3D A8 with
TE 540 3D FZ/1

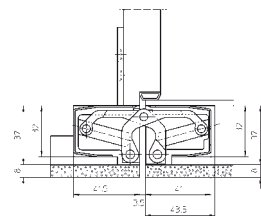

TE 640 3D A8 with
TE 640 3D FZ/1

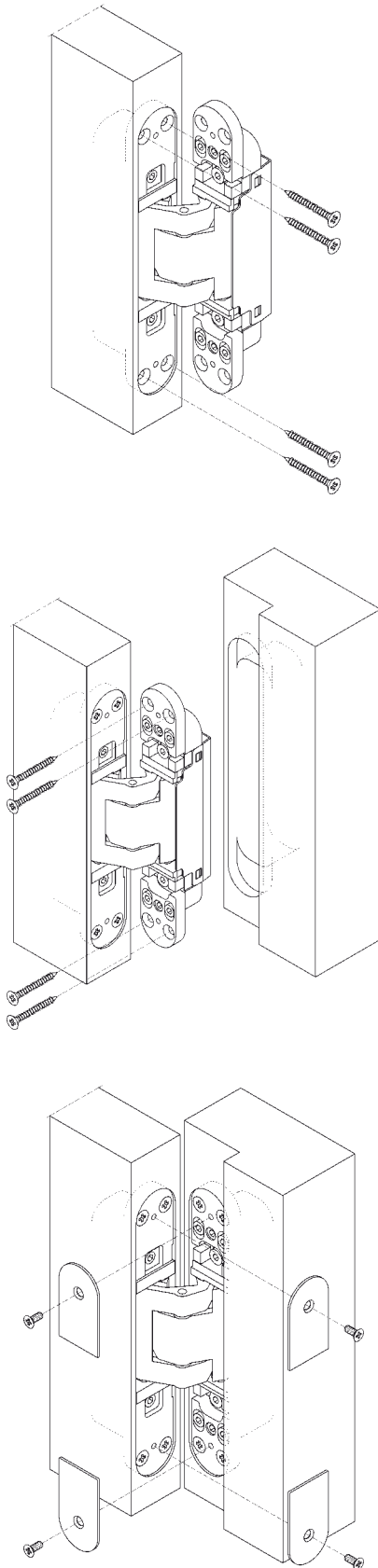

TECTUS series

DOOR

Fix door part with enclosed wood screws.

FRAME

Block frame

Conduct routing according to SIMONSWERK routing data. Use cutter 24 mm Ø (TE 240 3D cutter 16 mm Ø) and collar ring 30 mm Ø. Affix frame part with enclosed wood screws.

Casing frame

To guarantee for a stable mounting the use of an additional fixing plate is required. Affix the fixing plate by means of appropriate screws (not included) behind the casing. Affix the hinge by using enclosed M5 screws.

Steel frame

Affix frame part of the hinge with the prepared receiver inside the door frame by using the enclosed M5 screws.

Fix cover plates by means of the enclosed screws.

ADJUSTMENT

TECTUS series

Three-dimensionally, continuously adjustable

Side	+/- 3,0 mm
Height	+/- 3,0 mm
Depth	+/- 1,0 mm

Side adjustment

- Adjust the adjusting spindles using a 4 mm Allen key
- Twist left - towards hinge (max. 3 mm)
- Twist right - towards lock (max. 3 mm)

Height adjustment

- Slightly loosen the clamping screws
- Adjust the vertical position of the door by turning the lower height adjustment screw (turn the upper height adjustment screw in the opposite direction if necessary)
- Retighten the clamping screws

Depth adjustment

- Slightly loosen the fixing screws
- Put the door to the correct compression
- Retighten the clamping screws

All adjustments to be conducted by means of a 4 mm Allen key

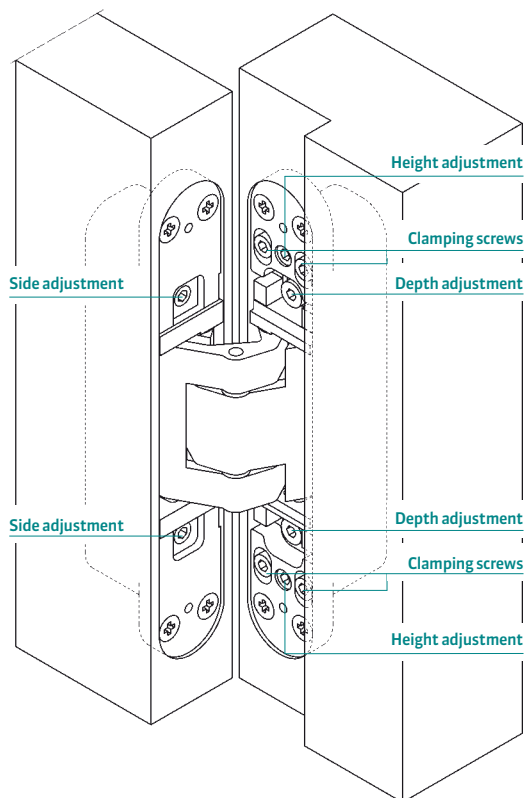

CALCULATION FORMULAS

Calculation of the milling width for timber frames

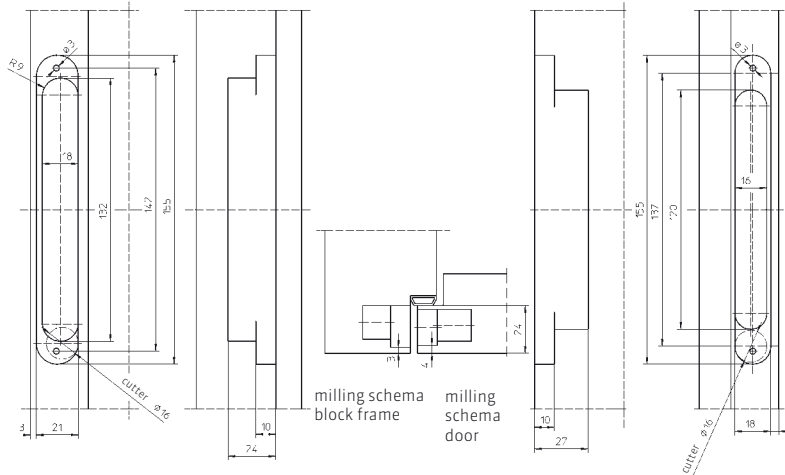

TE 240 3D

Conduct routing with cutter Ø 16 mm, collar ring Ø 30 mm and universal milling frame with routing templates No. 5 250691 6 (frame) and No. 5 250692 6 (door).

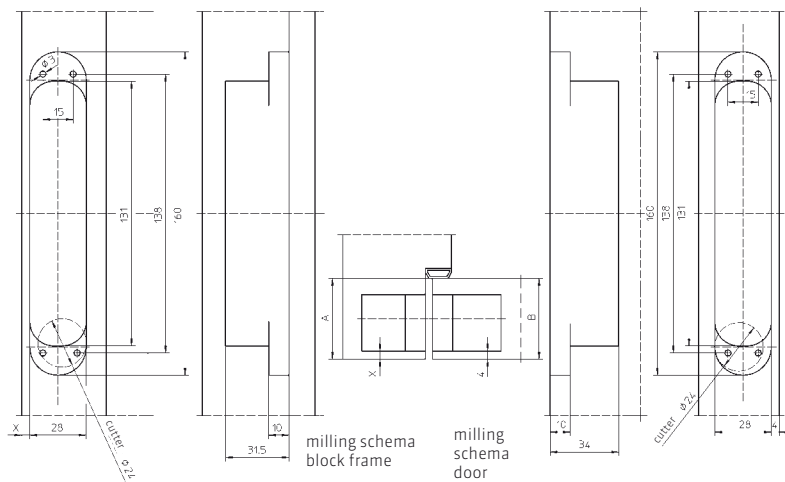

TE 340 3D

A = Depth of frame rebate up to sealing
 B = Thickness of door leaf resp. 1st door rebate
 A - B + 4 = Measure X

The result has to be a measure between 4,0 mm and max. 7,0 mm. (Steel frame: X = 5 mm)

Conduct routing with cutter Ø 24 mm, collar ring Ø 30 mm and universal milling frame with routing templates No. 5 250693 5 (Step 1) and No. 5 250694 5 (Step 2).

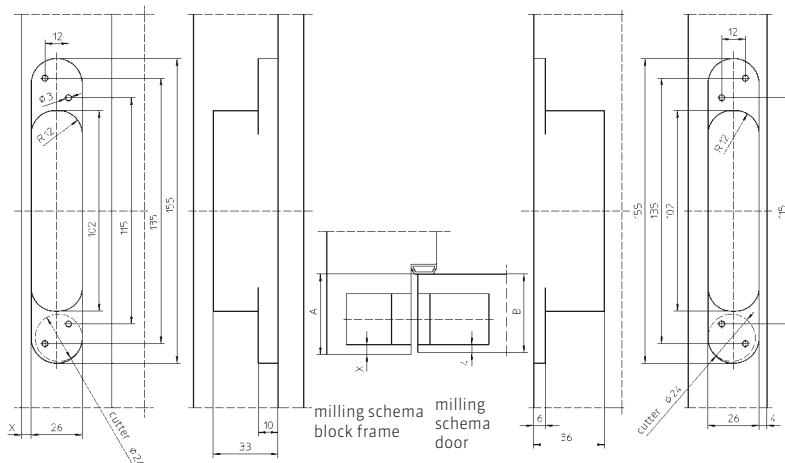

TE 525 3D

A = Depth of frame rebate up to sealing
 B = Thickness of door leaf resp. 1st door rebate
 A - B + 4 = Measure X

The result has to be a measure between 4,0 mm and max. 6,5 mm. (Steel frame: X = 5,0 mm)

Conduct routing with cutter Ø 24 mm, collar ring Ø 30 mm and universal milling frame with routing template No. 5 250547 6.

CALCULATION FORMULAS

Calculation of the milling width for timber frames

TE 540 3D

A = Depth of frame rebate up to sealing
 B = Thickness of door leaf resp. 1st door rebate
 $A - B + 4 = \text{Measure X}$

The result has to be a measure between 4,0 mm and max. 6,0 mm. (Steel frame: X = 5,0 mm)

Conduct routing with cutter $\varnothing 24$ mm, collar ring $\varnothing 30$ mm and universal milling frame with routing templates No. 5 250680 5 (Step 1) and No. 5 250681 5 (Step 2).



TE 640 3D

A = Depth of frame rebate up to sealing
 B = Thickness of door leaf resp. 1st door rebate
 $A - B + 4 = \text{Measure X}$

The result has to be a measure between 4,0 mm and max. 6,0 mm. (Steel frame: X = 5,0 mm)

Conduct routing with cutter $\varnothing 24$ mm, collar ring $\varnothing 30$ mm and universal milling frame with routing templates No. 5 250659 5 (Step 1) and No. 5 250689 5 (Step 2).

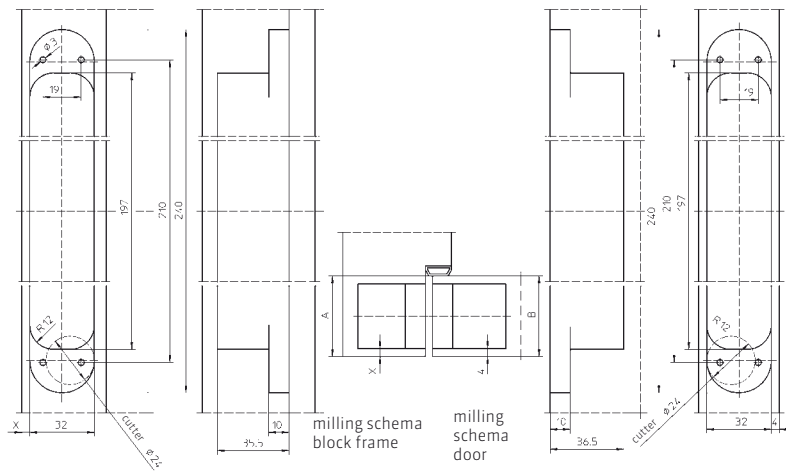

TE 540 3D A8

Conduct routing with cutter $\varnothing 24$ mm, collar ring $\varnothing 30$ mm and universal milling frame with routing templates No. 5 250680 5 (Step 1), No. 5 250681 5 (Step 2) and No. 5 250682 5 (Step 3).

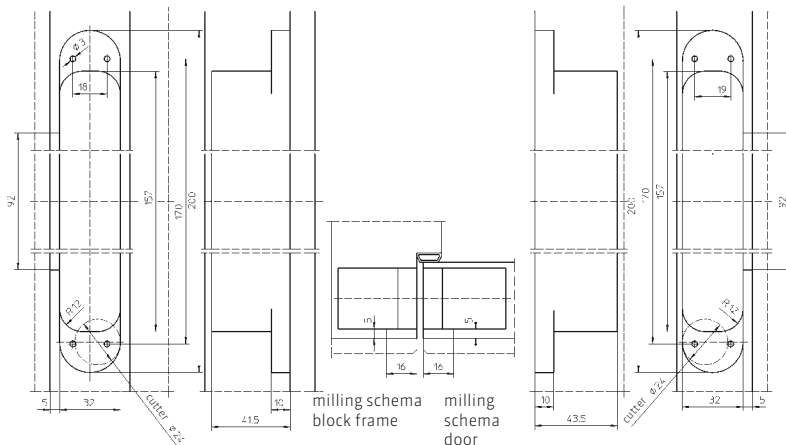

CALCULATION FORMULAS

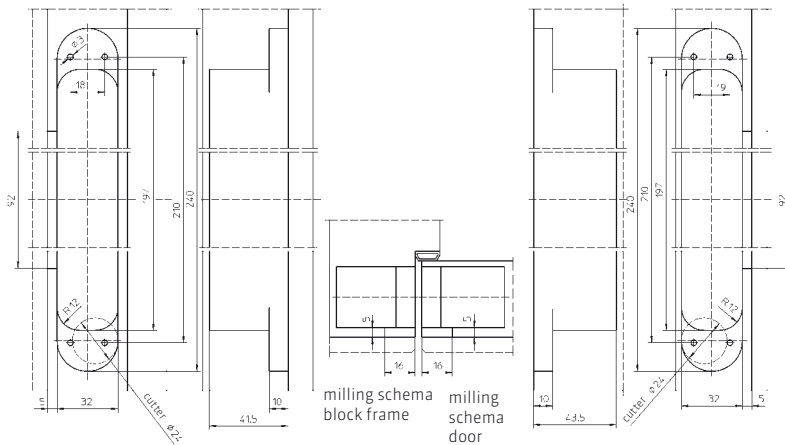

TE 640 3DA8

Conduct routing with cutter Ø 24 mm, collar ring Ø 30 mm and universal milling frame with routing templates No. 5 250659 5 (Step 1), No. 5 250689 5 (Step 2) and No. 5 250690 5 (Step 3).

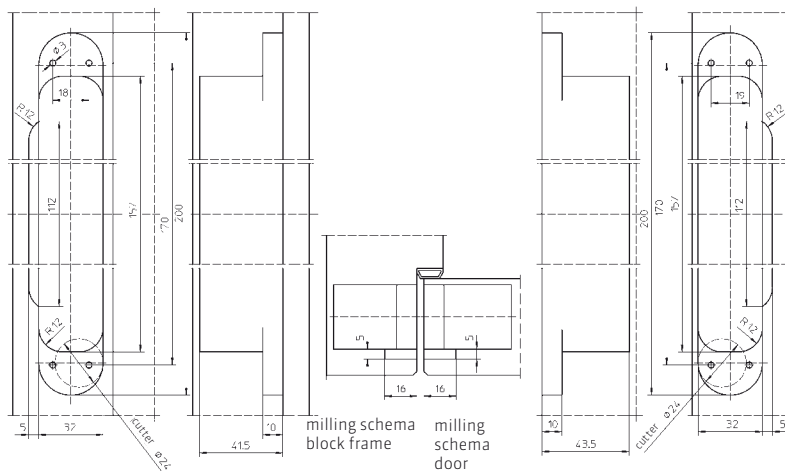

TE 540 3DA8 (without cladding)

A = Depth of frame rebate up to sealing
 B = Thickness of door leaf resp. 1st door rebate
 A - B + 4 = Measure X

The result has to be a measure between 4,0 mm and max. 6,0 mm. (Steel frame: X = 5,0 mm)

Conduct routing with cutter Ø 24 mm, collar ring Ø 30 mm and universal milling frame with routing templates No. 5 250680 5 (Step 1), No. 5 250681 5 (Step 2) and No. 5 250682 5 (Step 3).

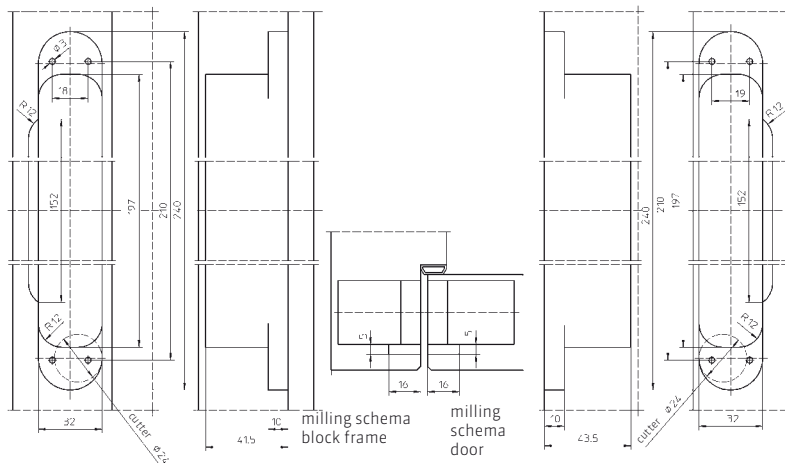

TE 640 3DA8 (without cladding)

A = Depth of frame rebate up to sealing
 B = Thickness of door leaf resp. 1st door rebate
 A - B + 4 = Measure X

The result has to be a measure between 4,0 mm and max. 6,0 mm. (Steel frame: X = 5,0 mm)

Mill with cutter Ø 24 mm, collar ring Ø 30 mm and universal milling frame with routing templates No. 5 250659 5 (Step 1), No. 5 250689 5 (Step 2) and No. 5 250690 5 (Step 3).

CONTAINS

 **SIMONSWERK**
TECTUS®

TE 240 3D
TE 340 3D
TE 540 3D
TE 640 3D
TE 540 3D A8
TE 640 3D A8
TE 525 3D

FURTHER BRANDS MADE BY SIMONSWERK

 **SIMONSWERK**
VARIANT® VX

 **SIMONSWERK**
VARIANT® VN

 **SIMONSWERK**
VARIANT® VG

 **SIMONSWERK**
VARIANT® V

 **SIMONSWERK**
BAKA®

 **SIMONSWERK**
SIKU®

 **SIMONSWERK**
ALPRO®

Broschüre TECTUS® - New Versions (completed edition)

10/2009
5 800313 0 00001/2.0



OUR PRODUCT INFORMATION SYSTEM
www.bandsysteme.com

SIMONSWERK GmbH

Bosfelder Weg 5
D - 33378 Rheda-Wiedenbrück

Phone +49 (0)5242 / 413-0
Fax +49 (0)5242 / 413-150

sales@simonswerk.de
www.simonswerk.com
www.bandsysteme.com